

1	Contents	
2	Introduction	2
2.1	Valve use	2
2.2	Application area	2
2.3	Incorrect use	2
3	Safety	2
4	Transport and storage	2
5	Installation instructions	2
5.1	Mounting	2
5.2	Installation into pipework	2
5.3	Operating space	2
5.4	Mounting space	2
6	Operation	3
6.1	Operation with air	3
6.2	Indication of valve position	3
6.3	Control unit	3
7	Cleaning and maintenance	3
7.1	Cleaning	3
7.2	Lead-time	3
7.3	Safety measures during maintenance	3
7.4	Grease to be used	3
7.5	Disassembling the valve	3
7.6	Assembling angle- and multiway valves	4
7.7	Assembling change-over valves	4
7.8	Disassembling and assembling the actuator	4
7.9	Failures	4
Appendix A:	Technical specification	5
	Version and ordering code	5
	Valve material	5
	Gasket material	5
	Air supply pressure	5
	Liquid operating pressure	5
	Operating temperature	5
	Air consumption	5
Appendix B:	Cross-section	6
Appendix C:	Parts and spare parts	7
	Parts	7
	Spare parts	7
	Ordering spare parts	7

2 Introduction

2.1 Valve use

The HOVAP Basicflow process valve series 9800 is a valve with a single seat. This valve can be supplied as angle-, multiway- and change-over valve.

2.2 Application area

The valve has been designed for use in the food & beverage and pharmaceutical industries.

2.3 Incorrect use

The valve is not suitable for use in gas systems.

Liquids with hard solid parts cause increased wear to the gaskets.

3 Safety

Prevent that, during maintenance, liquids can pressurize the pipework in which the valve has been installed.

There must be a free space of at least 200 mm above the valve. This prevents the jamming of parts of the body during opening/closing of the valve.

Prevent that fingers or hand get jammed between valve and seats during operation of a disconnected valve.

During cleaning at elevated temperatures, the valve can become so hot that touching the surface causes burning.

Before disassembling a spring-to-close valve, the spring pressure must be eased by opening the valve with the air supply.

4 Transport and storage

The valve has been wrapped in plastic. This prevents dust and dirt entering the valve interior. Re-wrap the interior when the valve is unpacked for installation of the body into the pipework. The quality of o-rings may deteriorate during long-term storage.

5 Installation instructions

5.1 Mounting

If possible, install the valve such that it closes against the flow direction. This prevents water hammer.

5.2 Installation into pipework

The valve can be welded in every position in the pipework. Remove the valve internal parts, together with O-rings and gaskets, before welding.

5.3 Operating space

A free space of at least 50 mm is required above the valve.

5.4 Mounting space

To allow valve assembly and disassembly, a free space at least 250 mm is required above the actuator.

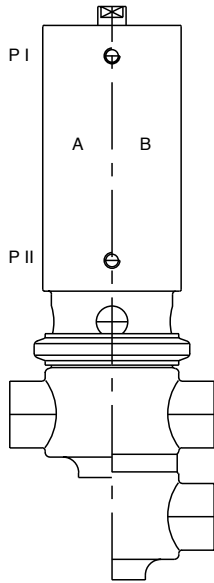

6 Operation

6.1 Operation with air

The valve is provided with two air connections with 1/8" BSP female thread.

- Angle- and multiway valves (A):

P I: Close valve (for spring-to-open and double-acting valves).

P II: Open valve (for spring-to-close valves).

- Change-over valves (B):

P I: Connect lower and top body.

Close bottom port (for spring-to-open and double-acting valves)

P II: Disconnect lower and top body.

Opening bottom port (for spring-to-close valves).

The spring action must not be amplified by supplying air. This causes damage to the valve parts.

6.2 Indication of valve position.

The valve can be provided with a bracket for proximity switches. Following positions are possible:

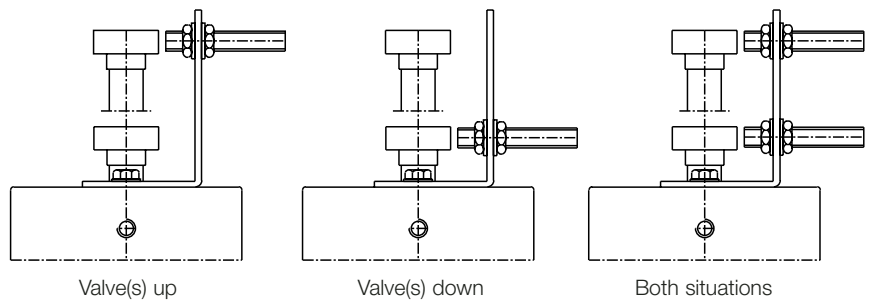

6.3 Control unit

The valve can also be provided with a control unit. Most commercially available units can be fitted.

7 Cleaning and maintenance

(See Appendix A)

7.1 Cleaning

The valve material is resistant to detergents that are commonly used in the food industry, such as a lye (NaOH) or acid (HNO₃) solution of about 2 1/2% at a temperature of about 80°C. After cleaning, the system must be rinsed with clean water to prevent corrosion.

7.2 Lead-time

Sealing and wearing parts of the valve must be checked once a year. For special applications (such as highly viscous or crystallizing liquids) the lead-time must be adjusted in consultation with the manufacturer.

7.3 Safety measures during maintenance

When disassembling the valve, the pipework must be empty. With disassembled valves, it must be prevented that the pipework can be filled accidentally by, e.g. starting a pump or activating a valve. Before disassembling a spring-to-close valve, it must be moved by the air supply to the open position. This prevents the valve being opened during assembly and disassembly by the spring's closing force.

7.4 Grease to be used

The O-rings must be greased with grease that has been approved for use in the food industry. We recommend Molykote 111.

7.5 Disassembling the valve

A - Remove, if present, the indicators.

B - For spring-to-close valves, supply pressurized air to P II.

C - Loosen clamp 12.

D - Pull actuator 8, together with interior, from valve body 1 or 2.

E - For spring-to-close valves, remove air pressure from P II; for spring-to-open multiway valves, supply pressurized air to P I.

F - Loosen valve/insert with shaft 3/13. Use spanner indication area A.

G - Angle- and multiway valves: remove valve plate 6 from valve and shaft 3.

Change-over valves: remove valve plate 7 from insert and shaft 13.

H - Loosen insert 5.

I - Check all O-rings.

7.6 Assembling angle- and multiway valves

General: Male thread connections must be secured with Loctite 243.

- A - Mount insert 5 with O-ring 20 on valve and shaft 3.
- B - Mount valve plate 6 with O-rings 21 and 22 over valve and shaft 3.
- C - Screw valve and shaft 3 into the actuator shaft.
- D - For spring-to-close valves, supply pressurized air to P II
- E - Install actuator 8, together with valve interior in valve body 1.
- F - Fasten clamp 12.
- G - For spring-to-close valves, remove air pressure from P II.
- H - Check if the valve operates smoothly.
- I - Install, if required, the indicators.

7.7 Assembling change-over valves

General: Male thread connections must be secured with Loctite 243.

- A - Mount insert 5, change-over valve 4 and O-rings 20 on insert and shaft 13.
- B - Mount stem valve plate 7 with O-rings 21, 22 and 23 on insert and shaft 13.
- C - For spring-to-open valves, supply pressurized air to P I.
- D - Screw change-over valve 4 and stem valve plate 7 into the actuator shaft.
- E - For spring-to-open valves, remove air pressure from P I; for spring-to-close valves, supply pressurized air to P II.
- F - Install actuator 8, together with valve interior, in valve body 2.
- G - Fasten clamp 12.
- H - Check if the valve operates smoothly.
- I - Install, if required, the indicators.

7.8 Disassembling and assembling the actuator

The actuator can be disassembled and assembled by rotating the connection piece 9. The security spring 14 will be released. The actuator will not be under spring pressure. After disassembly, the O-rings 24, 25 and 26 and bearings 11 can be checked. If required, the spring action can now be changed from spring-to-close to spring-to-open, or vice versa, by rotating the internal parts 180 degrees. To prevent distortion, never clamp the cylinder at the centre, but always at the top edge.

When assembling the actuator, use 'Never Seeze WH Food Grade' grease on the connection piece surface in the actuator to avoid wear.

The spring housing contains springs under pressure, Never dismantle this part. Incorrect disassembly can cause serious injury!

7.9 Failures

Valve closes with great force

Valve closes in the flow direction. Try to install the valve such that the valve closes in the opposite direction. If this is not possible, install a 'throttling' actuator on top of the main actuator.

Valve is opened by liquid pressure

Liquid operating pressure is above 5 bar.

Air supply pressure is below 6 bar.

Leakage along stem valve

Check O-rings 21.

Leakage at clamp 12

Check O-rings 22.

Leakage along valve

Check O-ring(s) 20 and 23.

Air leakage via connections P I or P II or connection piece.

Check O-rings 24, 25 and 26.

Valve opens/closes slowly

Air supply pressure is below 6 bar.

Air tube is too long, is pinched, or the diameter is too small.

Liquid in the actuator.

Valve opens/closes with irregular movement

Check if there is liquid in the actuator.

Liquid in actuator

Put a water separator in the air supply.

Version and ordering code

The following versions are available:

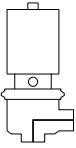
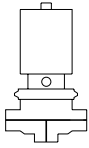
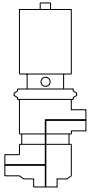
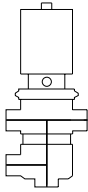
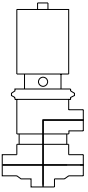
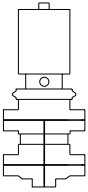
Version						
Ordering code	9801	9802	9811	9812	9821	9822

Valve material

All metal parts that come into contact with the liquid are made of stainless steel according to W.Nr. 1.4401. The metal parts that do not come into contact with the liquid are made of stainless steel W.Nr. 1.4301. The actuator bearings are made of polyacetate.

Gasket material

The O-rings that come into contact with the liquid are made of EPDM. Alternatives are available.

Air supply pressure

The air supply pressure must be between 5 and 10 bar. We recommend dry air of 6 bar.

Liquid operating pressure

The maximum liquid operating pressure for spring-to-close and spring-to-open valves is 5 bar. For double-acting valves this is 10 bar. These values will be reached at an air supply pressure of 6 bar.

Operating temperature

Valves with standard O-rings can resist a maximum temperature of 140°C.

Air consumption

The air consumption in nl. per stroke is given in the table below. The consumption is calculated at 6 bar air pressure.

Dimension	Spring-to-close and spring-to-open	Double acting
1 1/2"	1.0	4.3
2"	1.3	6.4
2 1/2"	2.4	11.1
3"	3.7	16.8
4"	6.5	29.7
5"	10.4	37.3

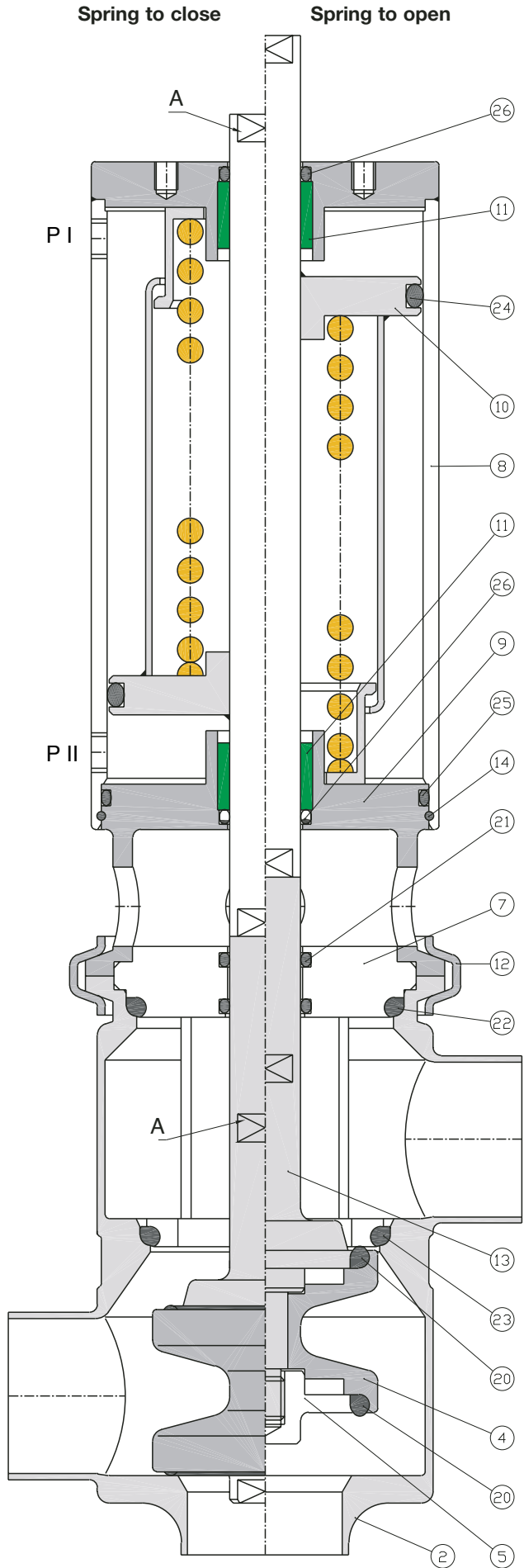
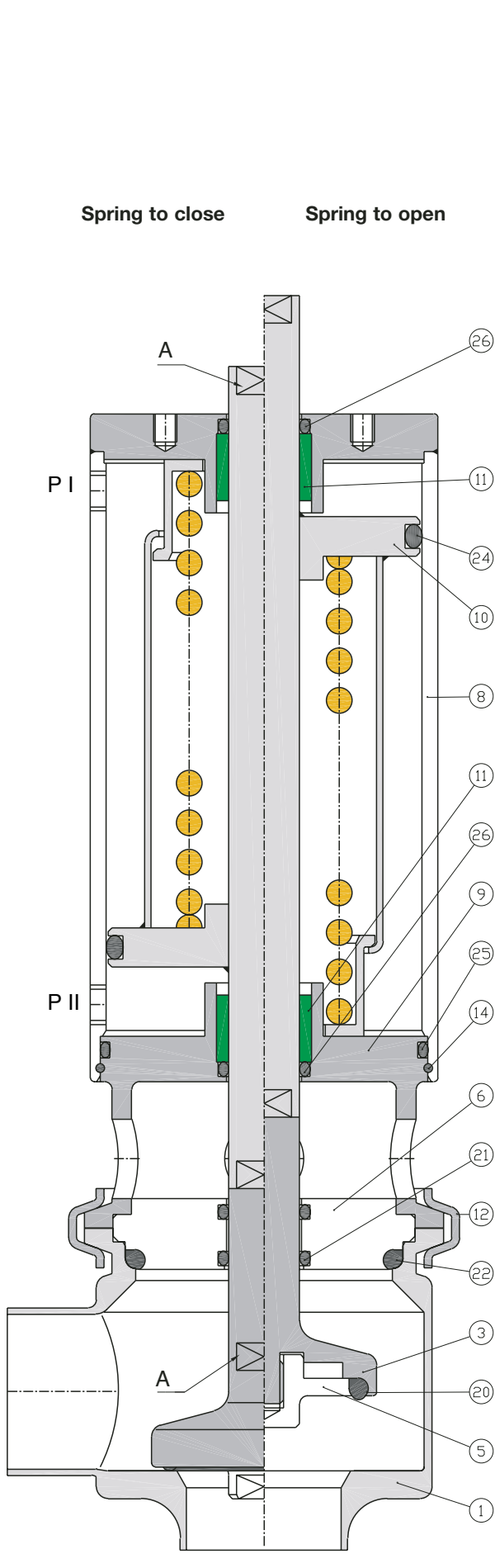

Parts

Ref. no.	Qty.	Material	Angle- and multiway valve	Change-over valve
1	1	W. Nr. 1.4401	Valve body	-
2	1	W. Nr. 1.4401	-	Valve body
3	1	W. Nr. 1.4401	Valve and shaft	-
4	1	W. Nr. 1.4401	-	Change-over valve
5	1	W. Nr. 1.4401	Insert	Insert
6	1	W. Nr. 1.4401	Stem valve plate	-
7	1	W. Nr. 1.4401	-	Stem valve plate
8	1	W. Nr. 1.4301	Actuator	Actuator
9	1	W. Nr. 1.4301	Connection piece	Connection piece
10	1	W. Nr. 1.4301	Internals actuator	Internals actuator
11	2	BP25	Bearing	Bearing
12	1	St. Steel	Clamp	Clamp
13	1	W. Nr. 1.4401	-	Insert and shaft
14	1	W. Nr. 1.4301	Security spring	Security spring
20	1/2	EPDM	O-ring	O-ring
21	2	EPDM	O-ring	O-ring
22	1	EPDM	O-ring	O-ring
23	1	EPDM	-	O-ring
24	1	NBR	O-ring	O-ring
25	1	FPM	O-ring	O-ring
26	2	FPM	O-ring	O-ring

Spare parts

Ref. no.	Descr.	1 1/2"	2"	2 1/2"	3"	4"	5"
		DN40	DN50		DN65/DN80	DN100	DN125
20	O-ring	43.82 x 5.33	50.17 x 5.33	62.87 x 5.33	81.92 x 5.33	100.97 x 5.33	126.37 x 7
21	O-ring	18 x 3	18 x 3	18 x 3	22 x 3	22 x 3	25 x 3
22	O-ring	56.52 x 5.33	66.04 x 5.33	75.57 x 5.33	94.62 x 5.33	113.67 x 5.33	158.12 x 5.33
23	O-ring	50.17 x 5.33	59.69 x 5.33	69.22 x 5.33	88.27 x 5.33	107.32 x 5.33	151.77 x 5.33
24	O-ring	70 x 5	80 x 5	100 x 5	120 x 5	150 x 5	183.52 x 7
25	O-ring	76 x 3	88 x 3	110 x 3	124.5 x 3	160 x 3	200 x 3
26	O-ring	18 x 3	18 x 3	18 x 3	22 x 3	22 x 3	25 x 3

Ordering spare parts

When ordering spare parts, please include the following information:

- The valve number.
- The valve ordering code. See Appendix A.
- The valve size.
- The valve part position number.
- The quality of any O-rings.